

833SOLAR.COM/DESCARGAS

Ballasted Mounting System

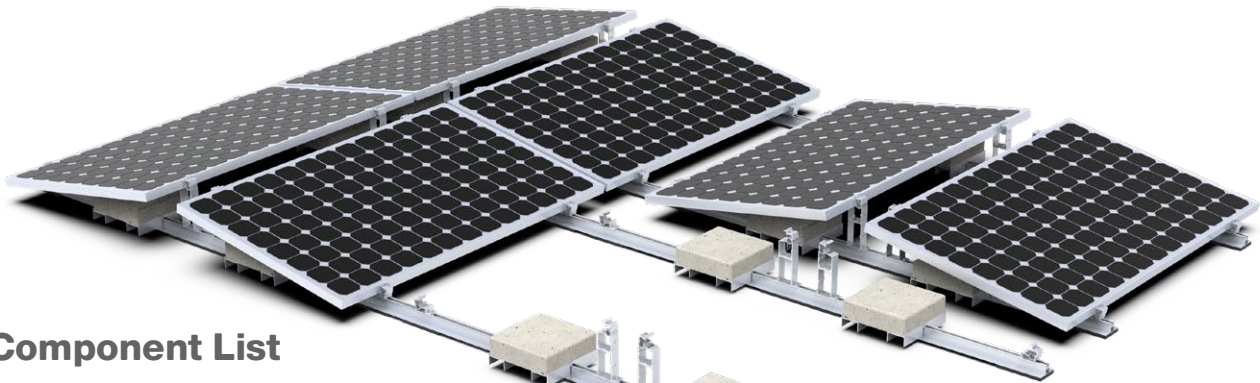

Component List



833-EO-GD-10

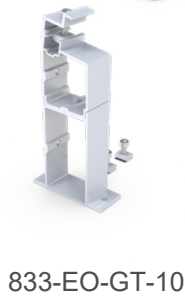

833-EO-GT-10

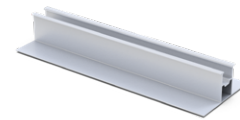

833-EO-R2600-41

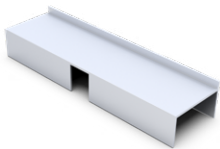

833-BO-BL

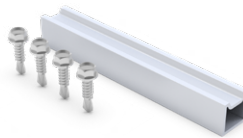

833-EOU-01

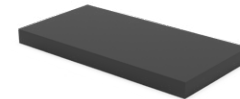

833-EO-AL

Technical features:

Product name	Ballasted- Series
Application	Concrete flat roof and trapezoidal sheet metal roof Tilt: 10°
System Material	Extruded aluminum profile 6005 T5, EPDM
Fastener material	Stainless steel 304
Finish	Anodized
Module orientation	Landscape

833SOLAR East & West Ballasted Systems suitable for concrete flat roof and trapezoidal sheet metal roof. Unlike the traditional solar panel fixing method, whose fixing point at the end of the long side of the panel, this series help solar panels to be fixed anywhere on the long side. Therefore, solar panels could withstand greater wind and snow pressure. There is no need to use expansion bolts or chemical bolts on the roof, no damage to roof. The system connects all the panels with the rails into a whole. East-west facing panels have a great effect on resisting wind loads. A combination of high quality aluminium components make a robust, reliable system and quick and easy installation.

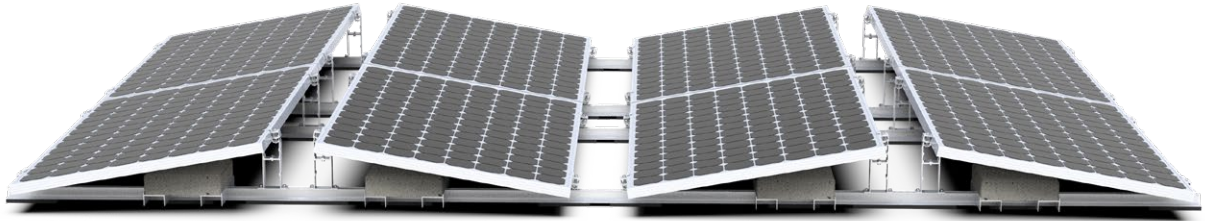

Product Feature:

Solar panels could withstand greater wind and snow pressure.

Maximal area utilized.

Maximal PV quantity installed.

Maximized roof space utilized, and PV quantity installed.

Better panel output.

Solar PV to be fast and easily installed on a flat roof with 10 tilt degree inclination.

All parts are made of extruded aluminum, with stainless steel 304 fasteners.

EPDM foam tape is installed at the bottom of the system, separated the roof and system.

EPDM foam tape provides better friction and compensates for the height difference when the roof is uneven.

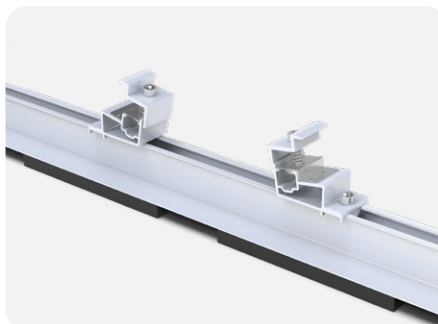
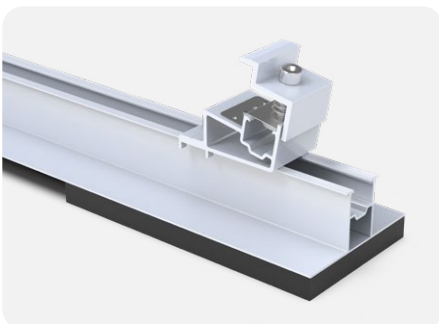
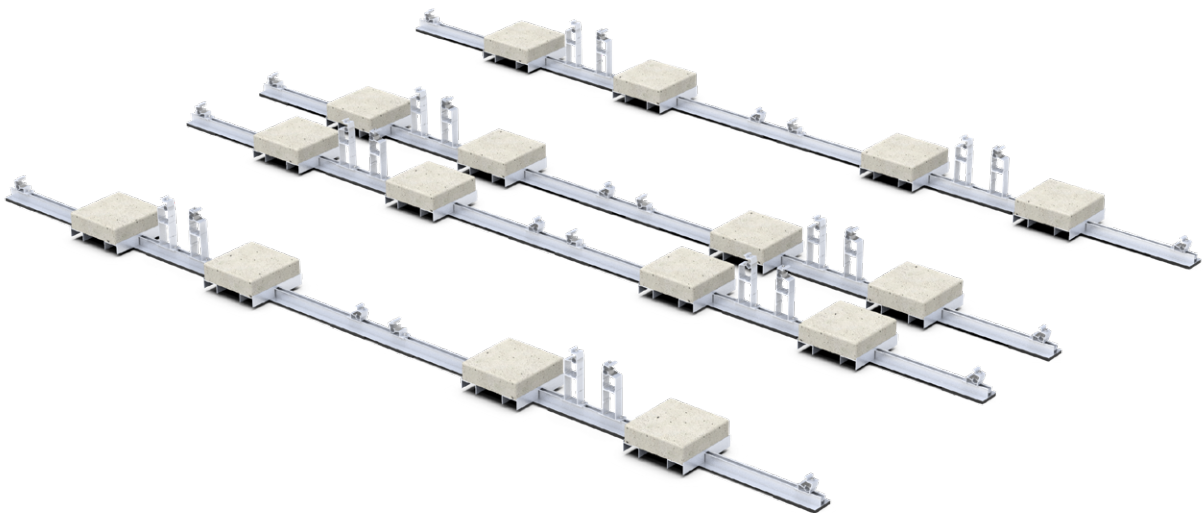

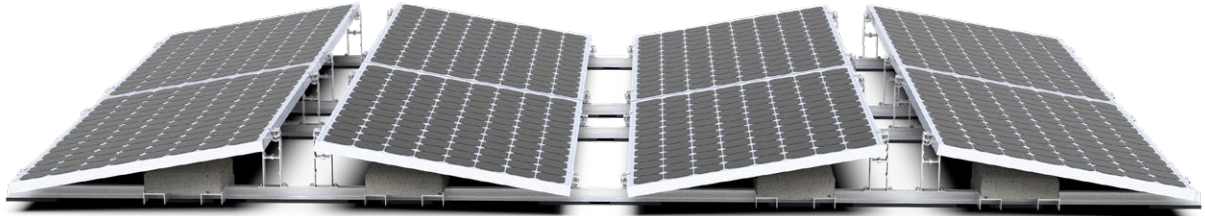

East & West 10° for concrete flat roof

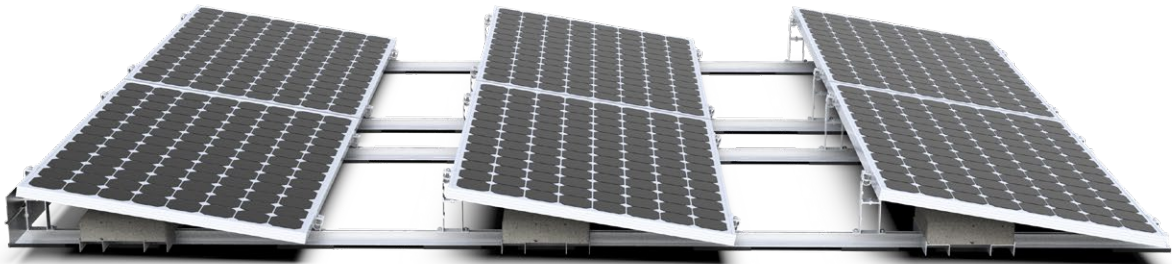

South or North 10° for concrete flat roof

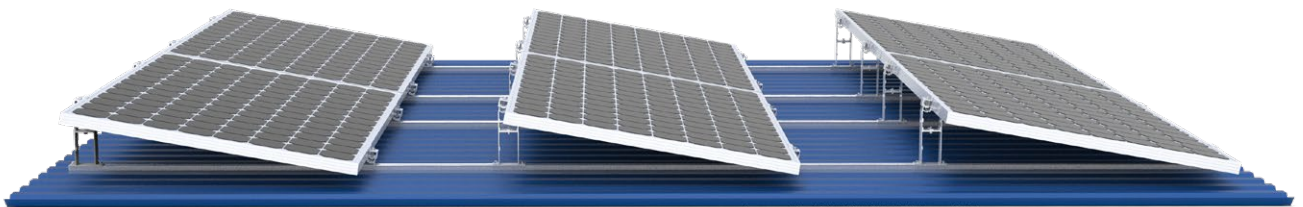

South or North 10° for trapezoidal sheet metal roof